

1570A

Altec Lansing

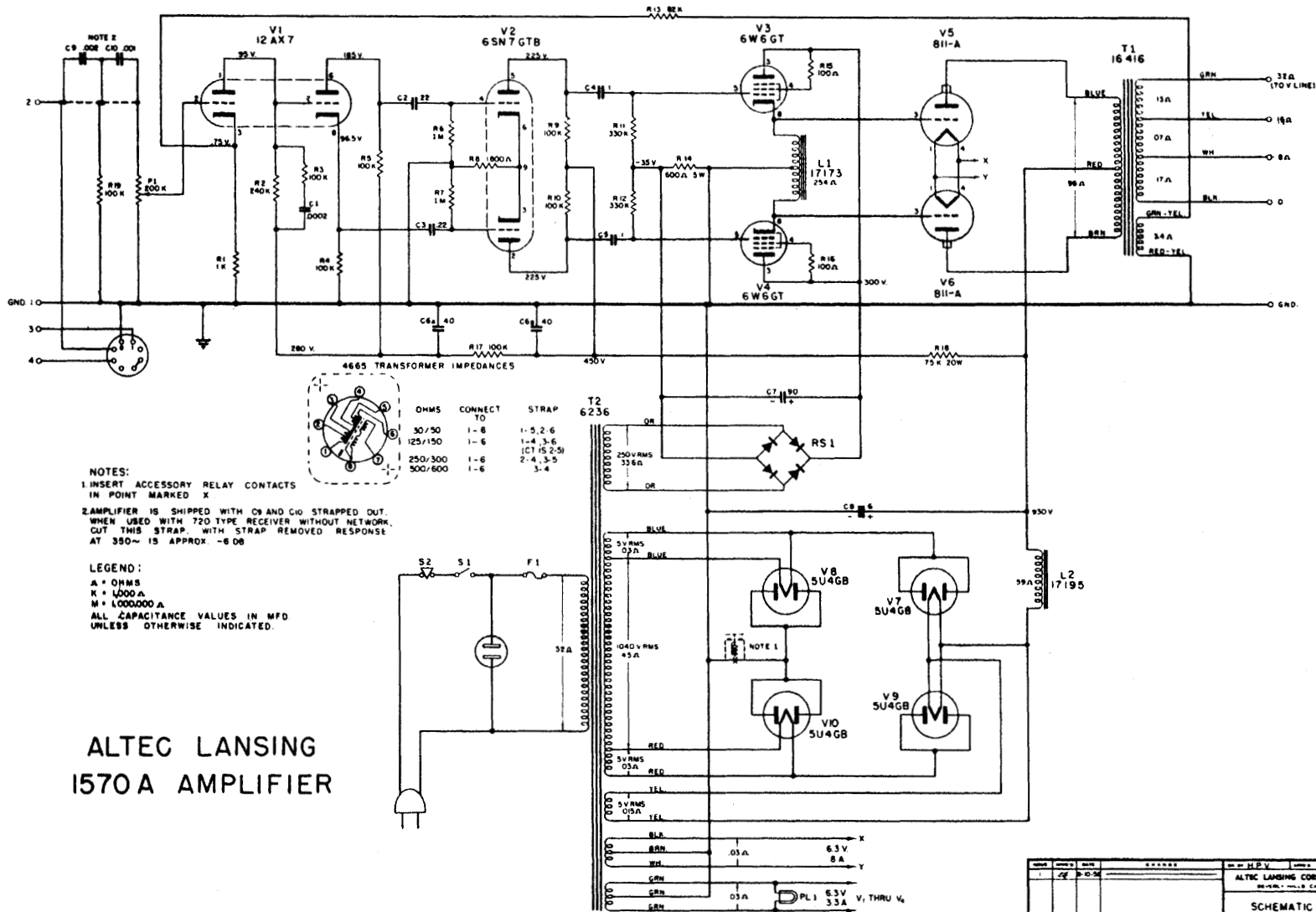

REV	DATE	BY	CHKD	APPROVED	BY
1	10-10-54				
ALTEC LANSING CORPORATION 1570A AMPLIFIER					
SCHEMATIC 1570A AMPLIFIER					
6177					